

SERIES
ACCESSORIES

Multi-user
outdoor panels

MA-02

MA-04

MA-08



User manual

Thank you for
choosing our equipment

SLINEX

{Design. Uniqueness. Innovations}

Attention!



As a result of continuous upgrades and functionality improvements, technical characteristics of the device can be changed without any preliminary declaration.
This manual can contain some inaccuracy or misprint. The owner reserves the right to make corrections to the information described in the user manual and device package.
The last revision of this manual is available on www.slinex.com

Safety instructions

Please read and keep that manual.
The device installation process should be carried out by the qualified specialists.
Use the device from the $-40\text{ }^{\circ}\text{C}$ to $+65\text{ }^{\circ}\text{C}$ ($-40\text{ }^{\circ}\text{F}$ to $149\text{ }^{\circ}\text{F}$), always keep it within that temperature range.
Installation surface should be free from vibration and impact influence.
Keep this device far from open sources of heat, such as radiators, heaters, and ovens.
The device can be installed near other electronic equipment in case if the temperature of the environment does not exceed previously mentioned range.
The device should be protected from the direct influence of the natural phenomena, such as direct sunlight, rain or snow.
Don't use aggressive or abradant detergent for the device surface cleaning.
Use soft wet cloth or tissues to remove strong dirt.

Nature protection



Don't throw away the device with other industrial or nutritive trash if you see that symbol. Some regions have separation and recycling systems for the electronic equipment. Connect with local authorities to receive information about recycling of electronic equipment for your region.

Rights and limitation of liability

All rights reserved. Any part of that document can not be published in any form, translated into other languages or reproduced in any way including electronic or mechanical.
Document recording and copying are strictly forbidden without owner permission.

Table of contents

1. Package	3
2. Specification	3
3. Description	4
4. Installation	5
5. Connectors	5
6. Schematic diagrams	6
7. ID card reader settings	8
8. Sound and visual indication	10
9. Unlock time setting	10
10. Name plates	11
11. Limited Warranty	12

1. Package

- MA-02 (MA-04 or MA-08) outdoor panel – 1 pc.
- Power supply – 1 pc.
- Flush mount installation box – 1 pc.
- ID cards – 3 pcs.
- Connection wires kit – 1 pkg.
- Mounting screws and anchors – 1 pkg.
- User manual – 1 pc.

2. Specification

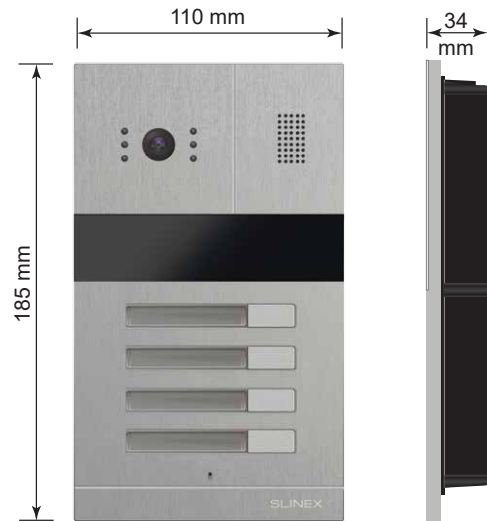

Sensor type	1/4" CMOS
Resolution	960 TV-lines
View angle	138°
Night backlight	Infrared LED's. 1,5 m distance
Voltage	+12V
Lock relay continuous current	10A
Power consumption	6 W in working mode
ID cards	EM-Marin, Mifare (refer to page 8 for more info)
Installation type	Flush or surface mount
Panel dimensions (installation box)	110×185×34 mm (98×173×34 mm)
Working temperature	-40 ... +65 °C (-40 ... 149 °F)

3. Description

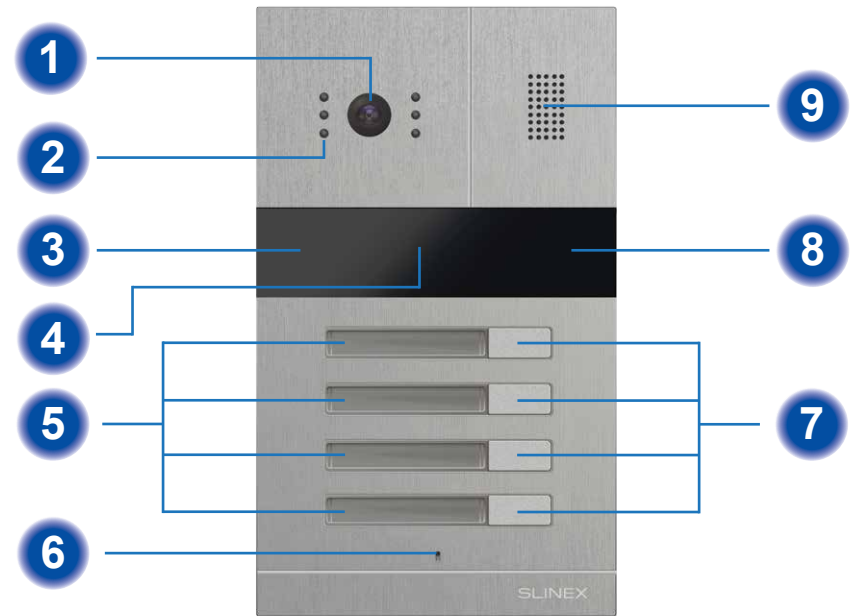

1	Video camera
2	Night infrared backlight
3	Wireless ID card reader
4	Light sensor
5	Name plates
6	Microphone
7	Call buttons
8	Status LED
9	Speaker

MA-02/04 outdoor panel has dual type ID card reader which maintains such wireless ID card standards: EM-Marin, Mifare Classic, Mifare ID, Ultralight, Ultralight EV1 and NFC.

4. Installation

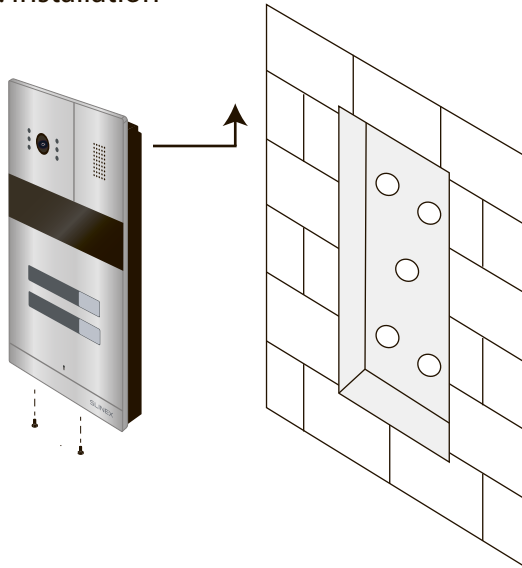

Outdoor panel flush mount process:

- 1) Prepare the hollow inside the wall according to the sizes mentioned on the 3rd page of the manual, 150-160 cm up from the floor line.
- 2) Mount flush mounting box into the hollow and fix it.
- 3) Connect all communication wires and insert the door panel inside the flush mounting box. Then fix it with two screws from the down side.

5. Connectors

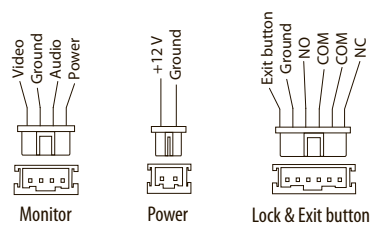
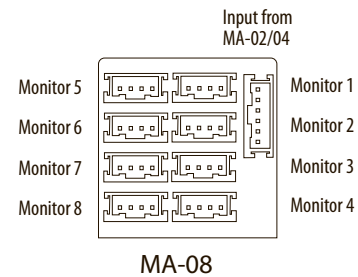
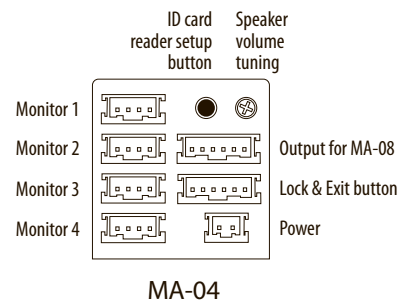
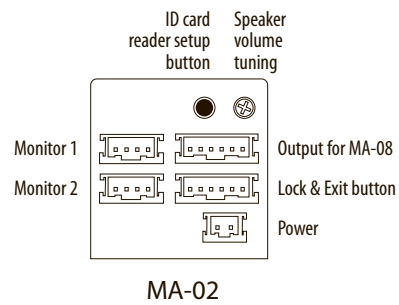

6. Schematic diagrams

Diagram 1. MA-02 and two monitors connection.

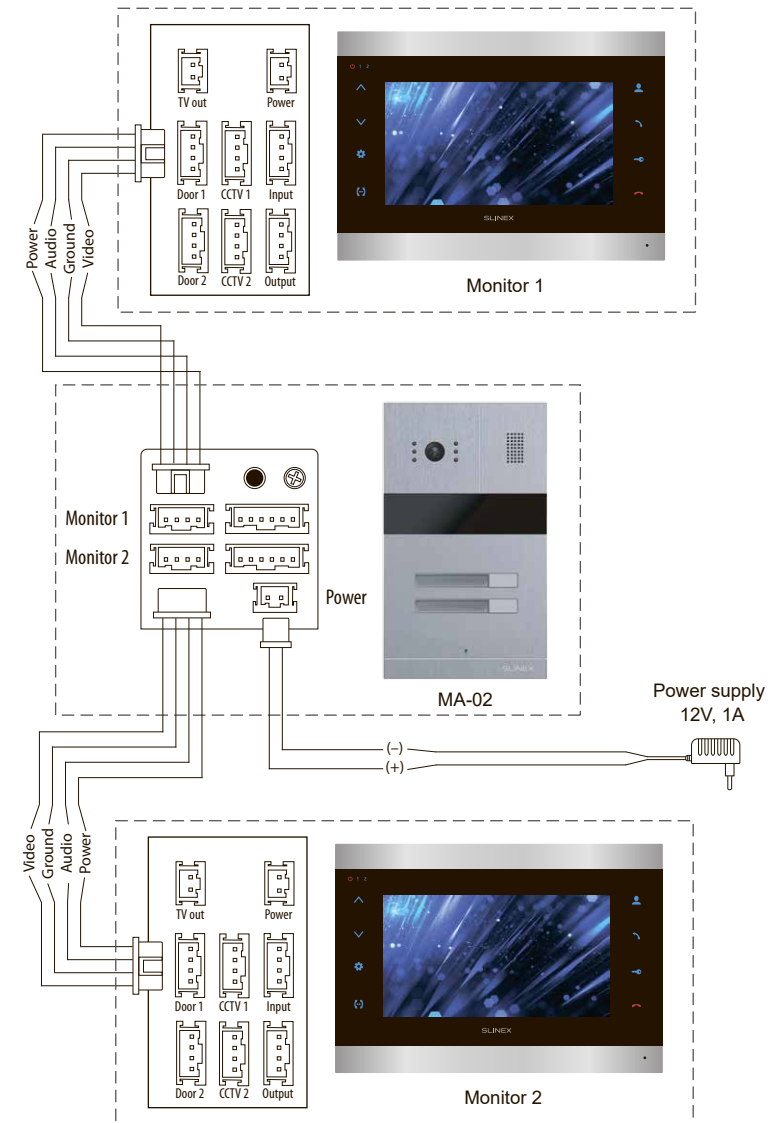

Diagram 2. MA-02 mechanical lock connection

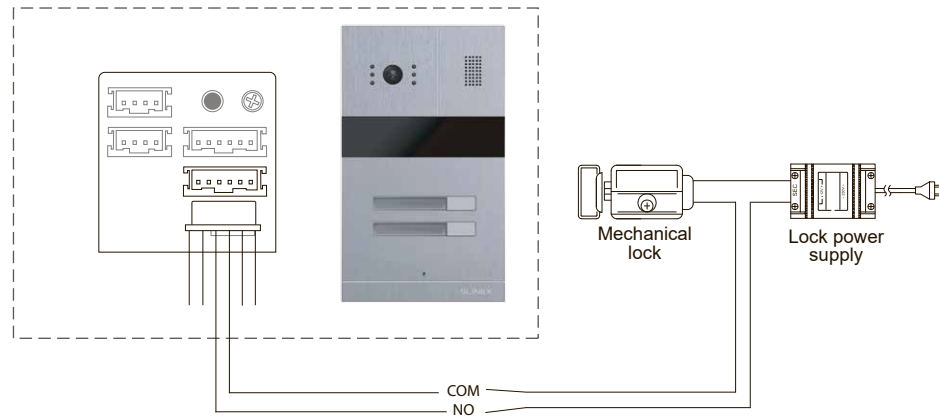

Diagram 3. MA-02 electromagnetic lock connection

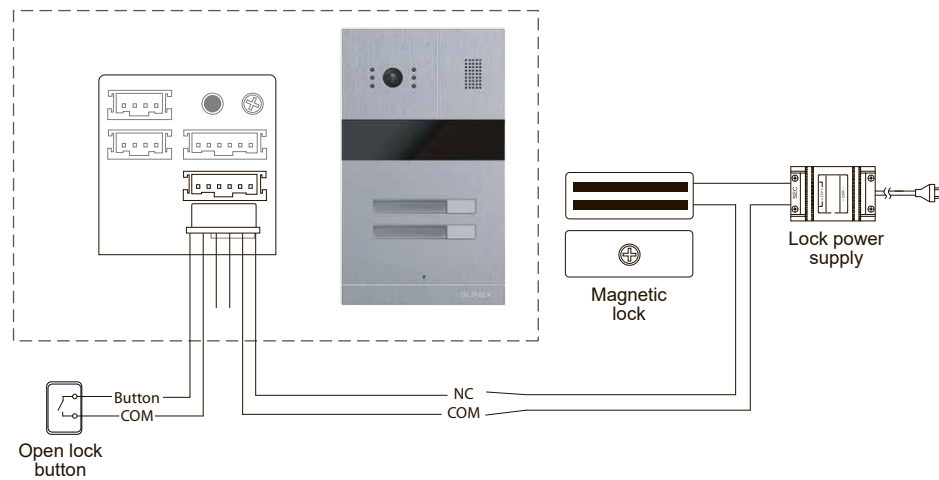
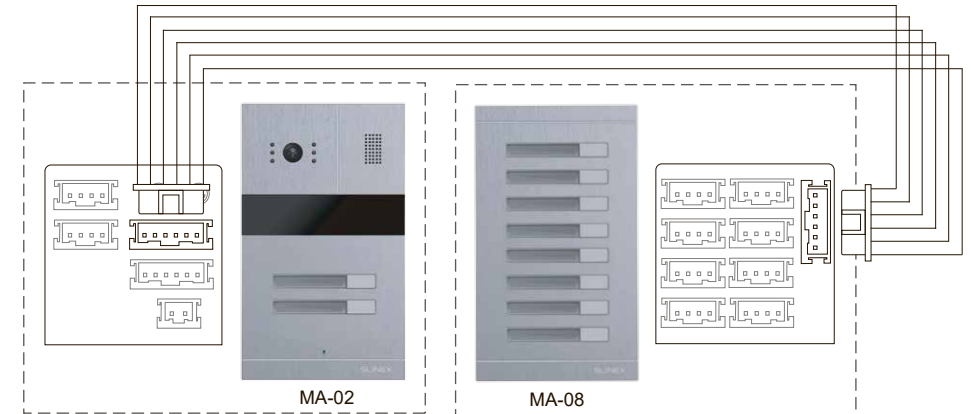

Diagram 3. MA-02 and MA-08 interconnection.



Note:

MA-08 can only be used as an extension unit for MA-02/04 outdoor panels. MA-08 can not be used as an independent outdoor panel.

7. ID card reader settings

Connect +12V power supply through the 2-pin connector on the back side of the outdoor panel red (+) and black (-) wires on the connector side. Note that (+) wire from power adapter has grey strips on the side.

Memory reset

Press and hold "ID card reader setup button" during 5 seconds (button situated on the back side of the outdoor panel, see page 5), until repeatable sound is heard. It means that ID card reader memory was formatted.







Manager ID card setup

1. Shortly press "ID card reader setup button" (on the back side of the outdoor panel, see page 5) to enter manager ID card setup mode. User will hear a short sound and status LED becomes blue.
2. Take the ID card that should be used as manager card and touch it near card reader zone on the front of the door panel. If manager card setup was successful then user will hear a sound signal. (If user doesn't touch ID card near card reader during 10 seconds then door panel will be automatically switched into standby mode). Only one manager ID card can be added to the card reader memory.

"Unlock ID cards setup" and "delete card" modes

1. In standby mode situate management card near the card reader to enter "unlock cards setup" mode. Outdoor panel will emit double sound and backlight of the call button will become blue.
2. Put every unlock ID card that needs to be added near card reader one by one. After each card reading, a double sound signal can be heard. In case if current ID card has been already added to the card reader memory then four-time sound signal can be heard while touching it near the card reader.
3. When all unlock ID cards have been added then put management card near the card reader to enter "delete card" mode. Door panel will emit double sound a signal and status LED will become red.
4. Put any unlock ID card that needs to be deleted near card reader while "delete card" mode is active. After double short sound current ID card will be deleted from the memory.
5. While "delete card" mode is active, situate management card near the card reader to exit into standby mode.
6. Wait for 10 seconds without any actions in «unlock ID cards setup» or «delete card» modes to exit into standby mode automatically.
7. Maximum unlock ID cards quantity that can be added to the card reader memory is 248 pcs.

8. Sound and visual indication

	Door unlock successful – one "beep" and blue status LED blinks twice
	No such unlock card – triple short "beep" and status LED blinks red twice
-	Standby mode – status LED doesn't work
	"Unlock ID cards setup" mode – double "beep" and status LED is constantly blue
	"Delete card" mode – double "beep" and status LED is constantly red
	Card setup successful – double "beep"
	Card is already added – four times short "beep"

9. Unlock time setting

Depending on the lock type connected to the door panel different unlock time should be used. While using an electromechanical lock, unlock time must be set under 2 seconds (1 second is typical value) to prevent electromechanical lock damaging. For the electromagnetic lock set unlock time to let visitors open the door during this time (typically it is 3-5 seconds).

Unlock time setting can be made in such way:

1. Shortly press "ID card reader setup button" (on the rear side of the door panel, see page 5) to enter unlock time setting.
2. On 2 users door panel use the 1st user button on the front to increase unlock time or the 2nd user button to decrease unlock time.
3. On 4 users door panel use the 2nd user button on the front to increase unlock time or the 3rd user button to decrease unlock time.
4. While unlock time setting you can hear sound signals from the door panel speaker. Sound signals quantity displaying current unlock time value in seconds. Unlock time value can be set up for 1 to 5 seconds.

10. Name plates

Here you can cut the name plates to insert under glass near the button. Each name plate has dimensions 47×8 mm. Glass can be disassembled with extractor from the outdoor panel kit.

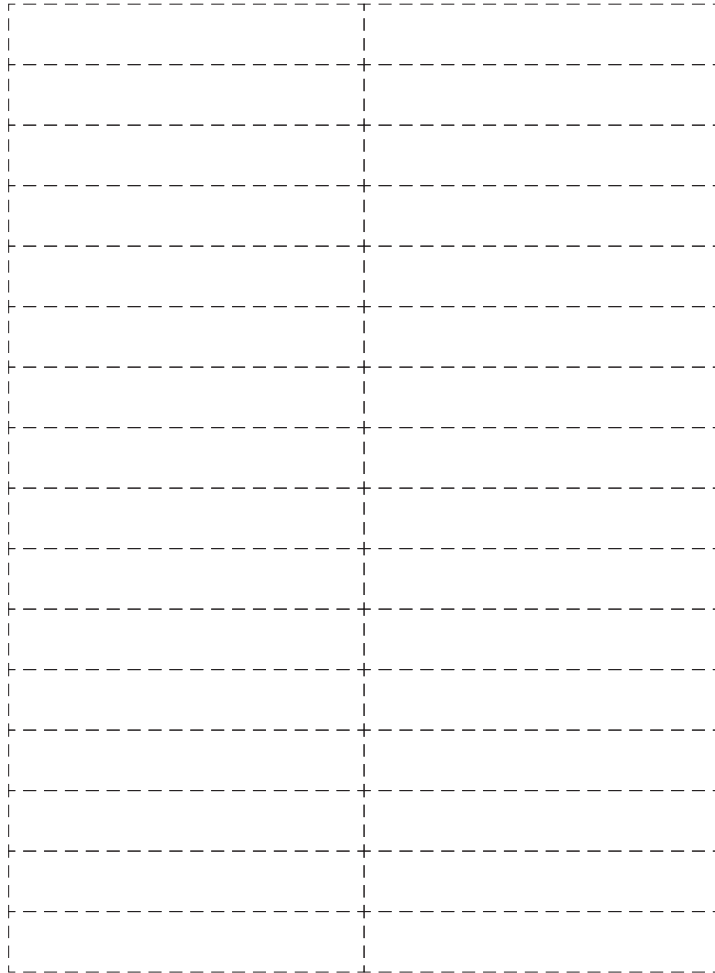

11. Limited warranty

Manufacturer guarantees product normal functioning during the warranty period if the user keeps all safety instructions described in that manual.

Warranty period is 12 months from the moment of the product purchasing (warranty period could be extended up to 24 months or more, depending on the local regulations).

Warranty period allows the user to make guarantee repair in cases when normal functioning of the product was violated by the fault of the manufacturer and the user haven't offended transporting, installation and working conditions.

This limited warranty does not cover any damage the product that results from improper installation, accident, abuse, misuse, natural disaster, insufficient or excessive electrical supply, abnormal mechanical or environmental conditions, or any unauthorized disassembly, repair or modification.

The warranty does not cover following cases:

- the product was damaged by the fault of the customer;
- the product wasn't properly installed according to recommendations from the manual;
- the sticker on the backside of the product was broken;
- the product was not used for its intended function.

This limited warranty covers only repair, replacement, refund or credit for defective products, as provided above. The manufacturer is not liable for and does not cover under warranty, any damages or losses of any kind whatsoever resulting from loss of, damage to, or corruption of, content or data or any costs associated with determining the source of system problems or removing, servicing or installing products. This warranty excludes third-party software, connected equipment or stored data. The manufacturer is therefore not liable for any losses or damage attributable to the third party software, connected equipment or stored data.

In case a product has been discontinued, the manufacturer shall either repair the product, offer to replace it with a comparable product or provide a refund at the lesser of the purchase price or the product's current value.

Repaired or replacement products will continue to be covered by this limited warranty for the remainder of the original warranty term.