

SERIES UNIQUE
DIRECT

SQ-07MT

7" video door phone
with touch screen

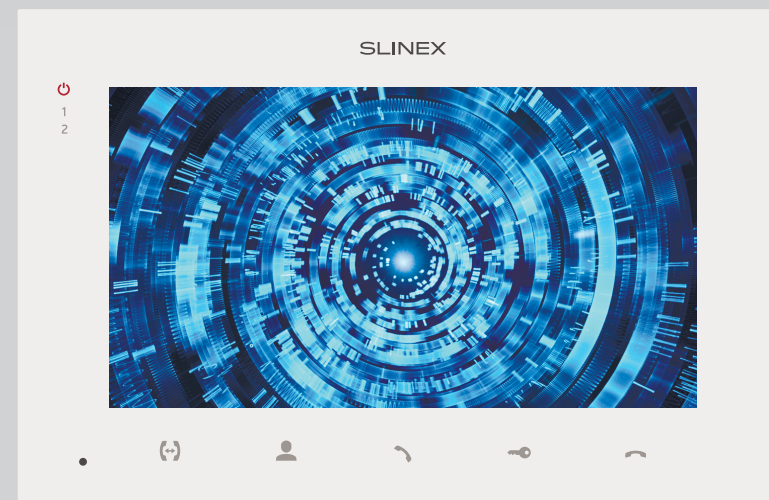

User manual

Thank you for the
choice of our equipment

SLINEX

{Design. Uniqueness. Innovation}

Attention!



As a result of continuous upgrades and functionality improvements, technical characteristics of the device can be changed without any preliminary declaration. This manual can contain some inaccuracy or misprint. The owner reserves the right to make corrections to the information described in the user manual and device package. The last revision of this manual is available on www.slinex.com

Safety instructions

Read and keep that manual.

The device installation process should be carried out by the qualified specialists.

Use the device from -10 °C to +55 °C, always keep it within that temperature range.

Installation surface should be free from vibration and impact influence.

Keep this device far from open sources of heat, such as radiators, heaters, and ovens.

The device can be installed near other electronic equipment in case if the temperature of the environment does not exceed previously mentioned range.

The device should be protected from the direct influence of the natural phenomena, such as direct sunlight, rain or snow.

Don't use aggressive or abradant detergent for the device surface cleaning.

Use soft wet cloth or tissue to remove strong dirt.

Don't overpower outlets. It can cause fire or electric shock.

Nature protection



Don't throw away the device with other industrial or nutritive trash if you see that symbol. Some regions have separation and recycling systems for the electronic equipment. Connect with local authorities to receive information about recycling of electronic equipment for your region.

Rights and limitation of liability

All rights reserved. Any part of that document can not be published in any form, translated into other languages or reproduced in any way including electronic or mechanical.

Document recording and copying is strictly denied without owner permission.

Table of contents

1. Package	3
2. Specification	3
3. Description	4
4. Installation	5
4.1 Cable requirements	5
4.2 Schematic diagrams	6
4.3 Unit mount	8
5. Operation	9
5.1 Incoming call	9
5.2 Door panel and camera monitoring	10
5.3 Incoming call redirection	11
5.4 Intercom	12
6. Monitor settings	12
6.1 Main screen navigation	12
6.2 System settings	13
6.3 Melody and volume settings	15
6.4 Working mode settings	16
6.5 Alarm settings	17
6.6 Display settings	20
6.7 Snapshots and records playback	21
7. Manual and automatic recording	23
8. External sensors motion detection recording	23
9. Limited Warranty	24

1. Package

SQ-07MT door monitor – 1 pc.
Wall mounting bracket – 1 pc.
Connection wires – 7 pcs.
Mounting screws and nuts – 1 pkg.
User manual – 1 pc.

2. Specification

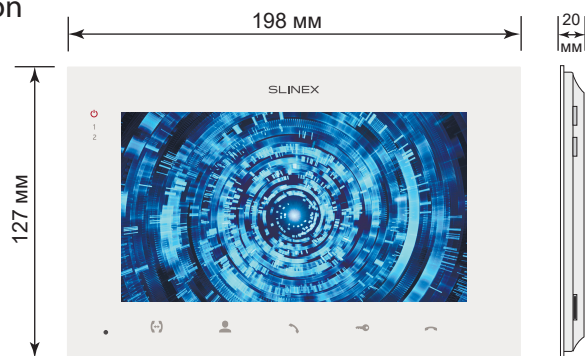

Screen	7", color TFT with touch screen
Resolution	800x480 pixels
Video system	PAL/NTSC
Audio type	Half duplex
Call time	120 seconds
Internal memory	100 snapshots
Memory extension slot	microSD, up to 32 GB
Standby mode power consumption	3 W
Working mode power consumption	7 W
Power supply	Built-in power supply, ~100–240 V
Mounting type	Surface mount
Size	197x127x20 mm
Working temperature	-10...+55 °C

3. Description

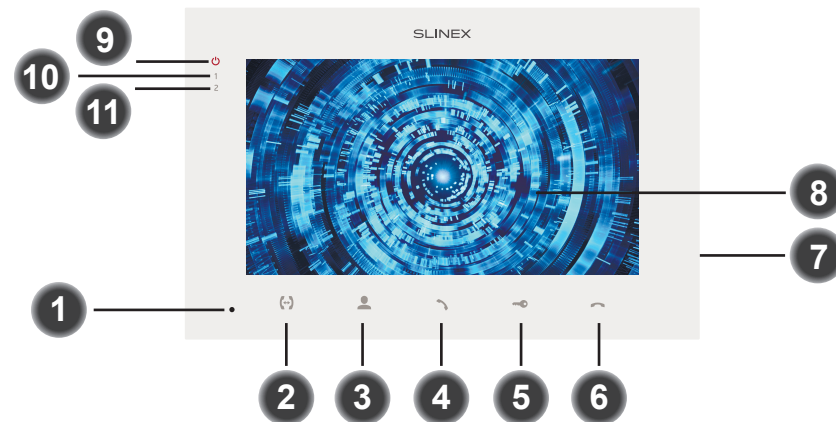

1	Microphone
2	«Intercom» button – call another monitor or incoming call redirection
3	«Monitor» button – door panel or camera image monitoring
4	«Answer» button – incoming call answer and start talking with the visitor
5	«Unlock» button – door unlocking
6	«Hang Up» button – stop conversation with the visitor / current system settings menu exit
7	MicroSD memory card slot (on the side of the monitor)
8	Touch display
9	Power LED. Active when the power is on.
10	First door panel LED. Active when the first door panel is on.
11	Second door panel LED. Active when the second door panel is on.

4. Installation

4.1 Cable requirements

Disconnect all power cables before device installation.

This device can be connected with such cable types depends on the distance between door monitor and door panel:

a) Use 4-wire cable with such parameters:

- distance up to 25 meters use a cable with 0,22 mm² square of one wire;
- distance 25 to 50 meters use a cable with 0,41 mm² square of one wire;
- distance 50 to 100 meters use a cable with 0,75 mm² square of one wire.

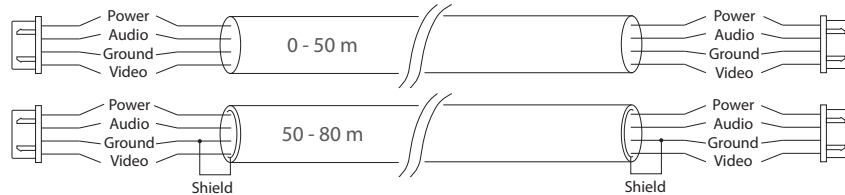

b) If the distance between door monitor and door panel is between 80 and 100 meters then use a 3-wire cable with 0,75 mm² square of one wire and RG-59 or RG-6 coaxial cable for the video signal.

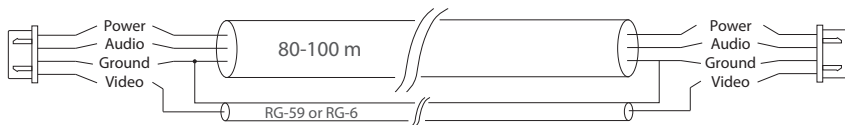

c) Shielded or non-shielded twisted pair (not recommended):

- distance up to 25 meters non-shielded twisted pair can be used;
- distance 25 to 50 meters shielded twisted pair should be used.

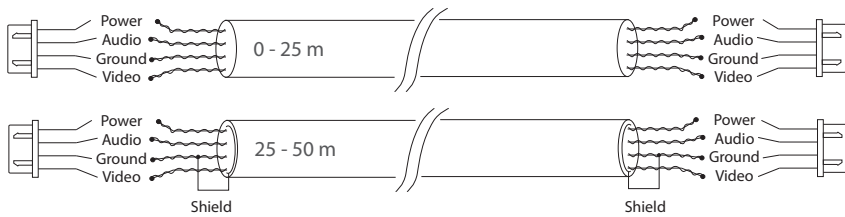

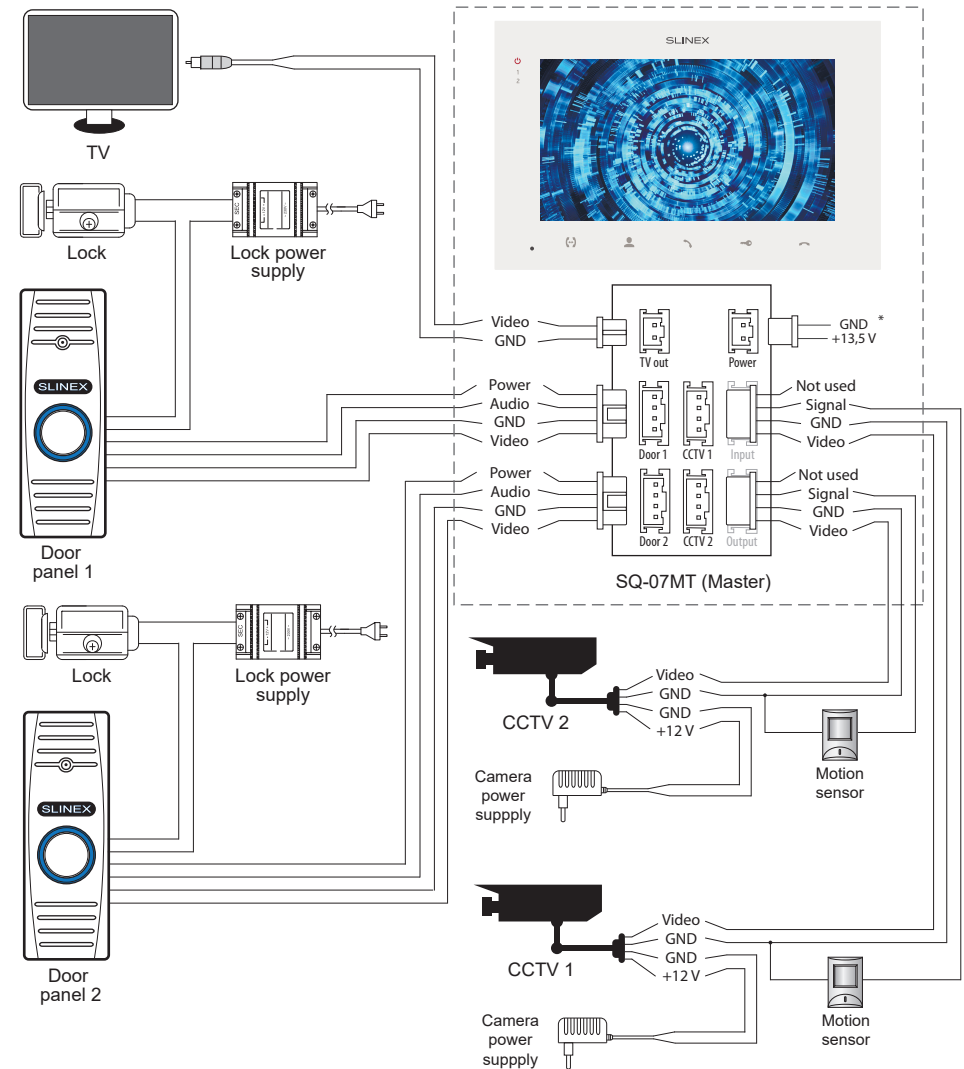

4.2 Schematic diagrams

Diagram 1. SQ-07MT door panels, cameras, locks and TV connection.



Notes:

- 1) If only one door panel connected to the monitor then you can exit monitoring mode by pressing «Monitor»  button one more time. (all other sources of video signal should be disabled in the monitor settings).
- 2) If several monitors connected into one system, the user can view the image from door panels and cameras on any monitor inside this system. The image will be transferred from the «Master» monitor door panels and cameras to the «Slave» monitors.
- 3) If someone presses call button on the door panel while monitoring is active then the image from this door panel appears on the monitor screen and call melody starts. Press «Answer»  button to start conversation.

5.3 Incoming call redirection

Two monitors connected into one system are used.

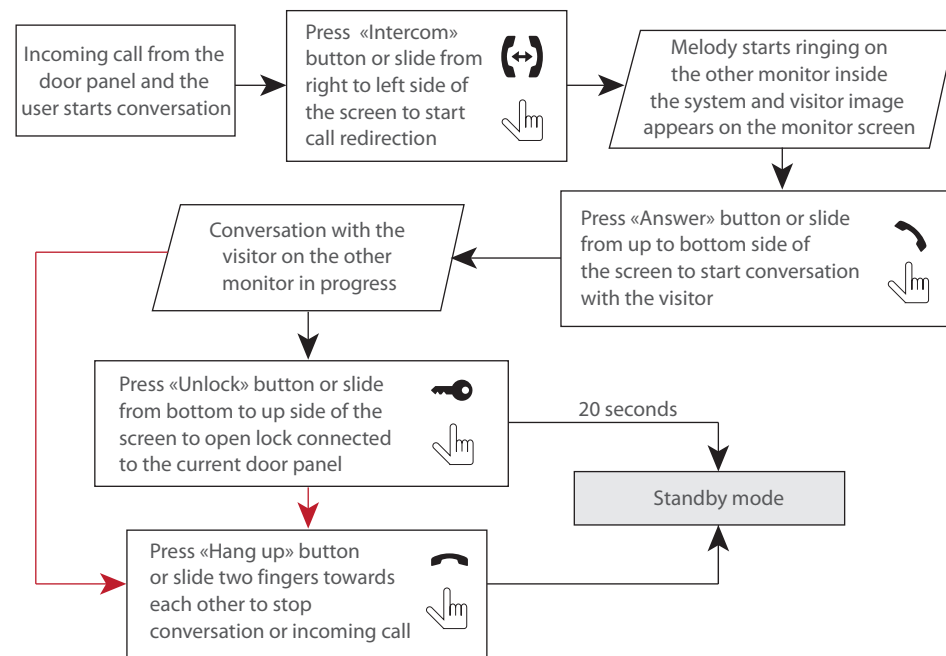

Note:

If incoming call was successfully redirected to the other monitor then current monitor will enter standby mode.

5.4 Intercom

Two monitors connected into one system are used.

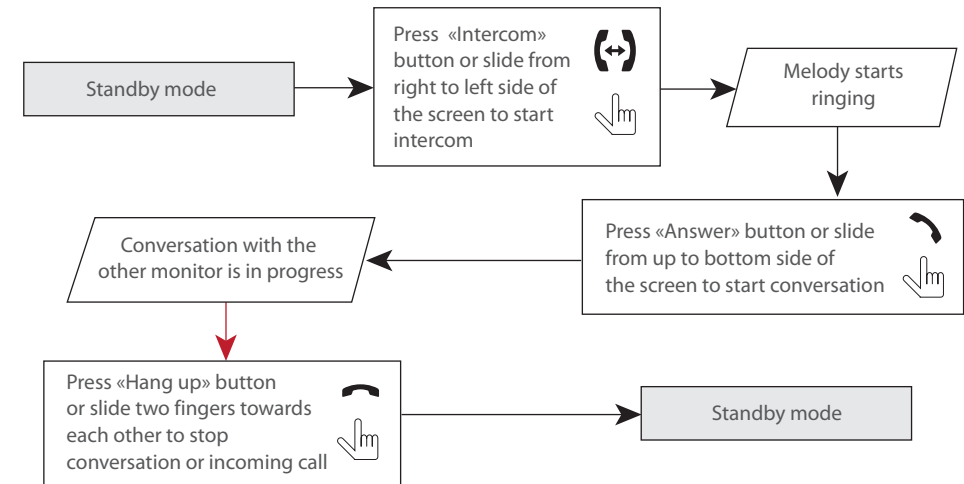





Note:

If someone pressed call button on the door panel while intercom is active then the image from this door panel will appear on the screen and call melody will starts. Press «Answer»  button to start conversation with the visitor.

6. Monitor settings

6.1 Main screen navigation

Press any place of the screen in standby mode to enter main screen. Then select and press any icon on the screen to enter corresponding sub menu. Change any parameters by up and down arrows situated near current parameter. After all settings have been made, press  icon or press  button to exit from current sub menu. Press  icon or press  button to exit from the main screen. No need to save any changes because they saved automatically after changing.

You can also monitor image from the door panels or cameras by entering «Monitor» menu from the main screen and selecting appropriate video source.

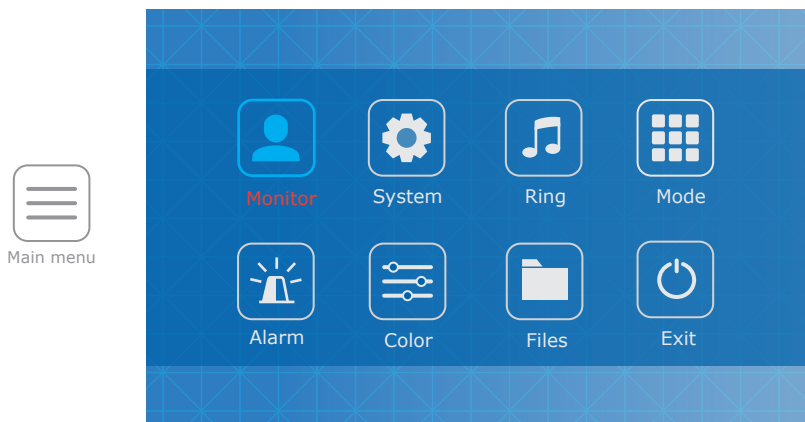

6.2 System settings

Press «System» icon in the main menu to enter system settings of the monitor:

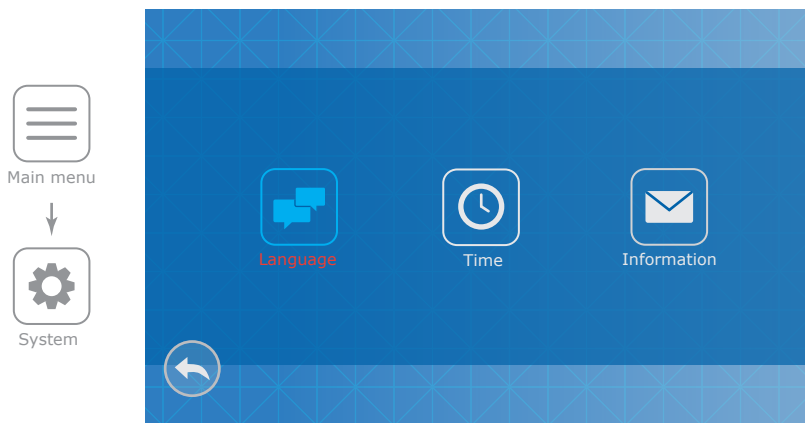

Following parameters are available in the «System» menu:

Language – the language of the settings menu.

Time – date and time settings.

Time display – date and time screensaver display in stndby mode (Off, 1, 3, 5, 10 min.).

Information:

Software version – current software version of the monitor.

Release date – date of software release.

Format SD – micro SD card formatting. Please format microSD card before use it. Recommended to use microSD cards of the 6-th class and above.

Format flash – internal memory formatting.

Backup pictures – copy files from the internal memory to microSD card.

Update – firmware updating of the monitor (place updating files on the microSD root folder).

Reboot – system reboot.

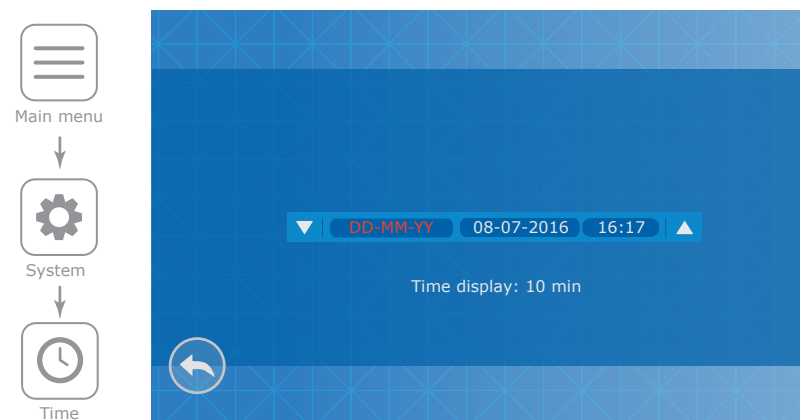
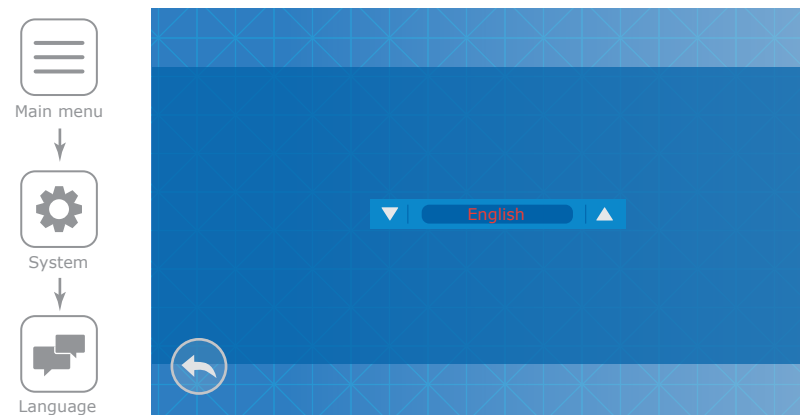

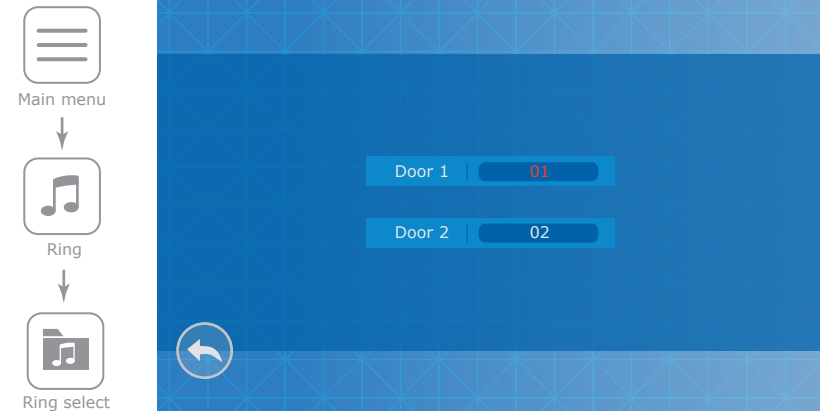
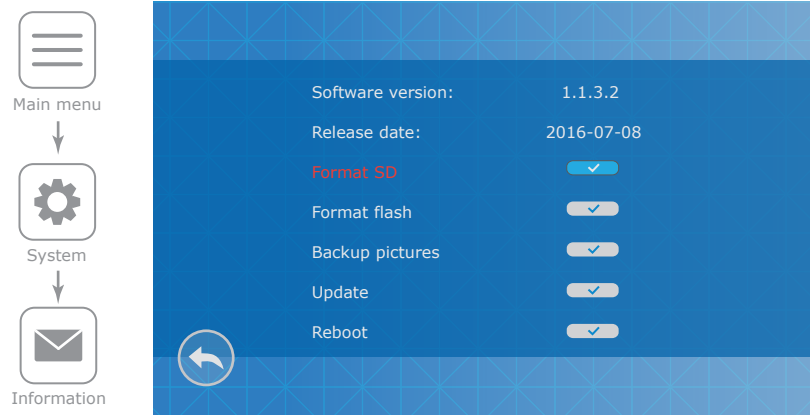

6.3 Melody and volume settings

Press «Ring» icon in the main menu to enter melody and volume settings.

Following parameters are available in the «Ring» menu:

Ring select – choose the melody for every door panel.

Ring volume – choose volume level (from 00 to 09) depending on the time of a day and also ringing time of the melody (10-45 seconds).

Silence mode – incoming call melody and keyboard muting, «On» or «Off».

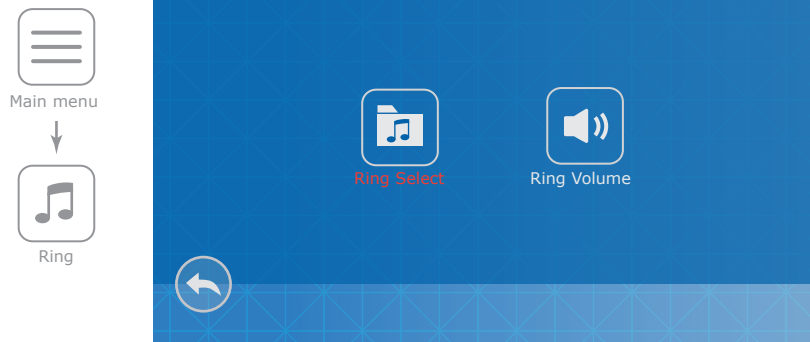

6.4 Working mode settings

Press «Mode» icon in the main menu to enter working mode settings.

Following parameters are available in the «Mode» menu:

Mode – choose «Master» if you use one monitor in the system or if it's the monitor which all the door panels and CCTV cameras are connected to. Choose «Slave» if there is more than one monitor in the system and no door panels or CCTV cameras connected to this monitor.

Door 2 status – «On» or «Off», include or exclude second door panel from the monitoring list.

Record mode: «Snapshot» – take snapshot while incoming call or manually;

«Record» – record video while incoming call or manually.

Door 1 unlock time – Door 1 relay delay time, 2 –10 seconds.

Door 2 unlock time – Door 2 relay delay time, 2 –10 seconds.

Key backlight – «On» or «Off».

Keyboard sound – «On» or «Off».

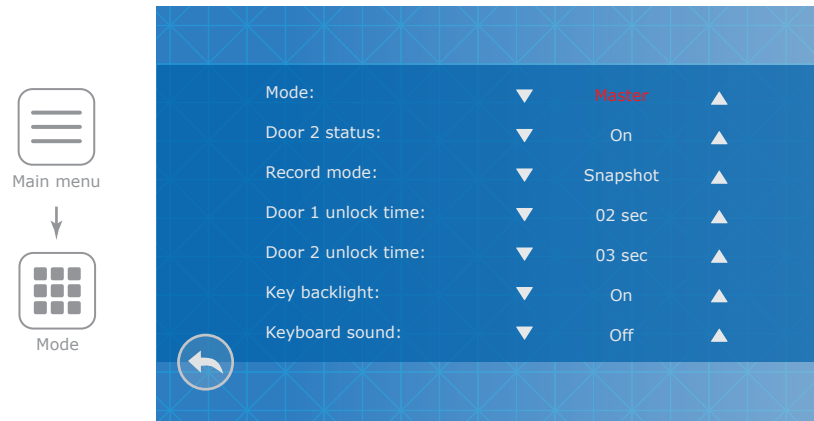

6.5 Alarm settings

Press «Alarm» icon in the main menu to enter alarm settings.

Following parameters are available in the «Alarm» menu:

CAM alarm – additional cameras alarm settings;

Motion detect – software motion detection.

CAM alarm includes next sub menu:

CAM1 sensor type: «NO», motion sensor with normally disconnected contacts are used;

«NC», motion sensor with normally connected contacts are used;

«Off», motion sensor doesn't used.

CAM2 sensor type: «NO», motion sensor with normally disconnected contacts are used;

«NC», motion sensor with normally connected contacts are used;

«Off», motion sensor doesn't used.

CAM1 – «On» or «Off», include or exclude first CCTV camera from the monitoring list.

CAM2 – «On» or «Off», include or exclude second CCTV camera from the monitoring list.

CAM1 ring time – alarm melody ringing time activated by CAM1 motion sensor, from 00 to 30 seconds.

CAM2 ring time – alarm melody ringing time activated by CAM2 motion sensor, from 00 to 30 seconds.

Alarm record: «Snapshot» – save photo if motion detection has occurred;

«Record» – save video if motion detection has occurred.

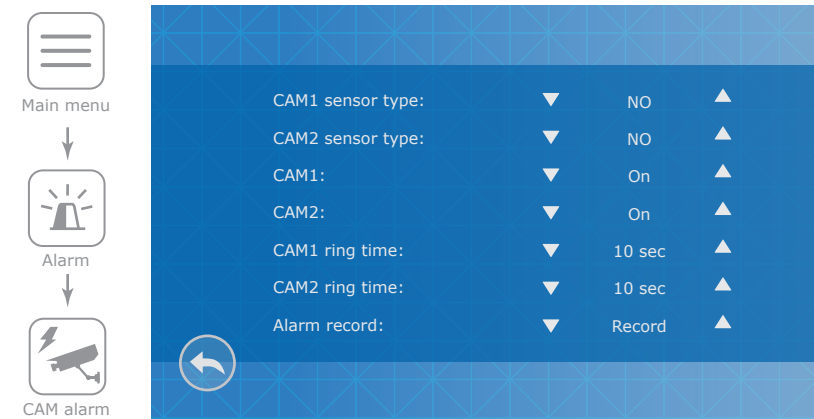

Software motion detector can observe and detect motion without any external sensors using any camera image changes with the time. Camera power that is used for motion detection should be constantly on to let the monitor log image changes and detect motion.

Motion detect includes next sub menu:

Motion detect source: «Off» – software detector is off;

«Door1» – motion detection on Door1;

«Door2» – motion detection on Door2;

«CAM1» – motion detection on CAM1;

«CAM2» – motion detection on CAM2.

Motion detect area – set image area which motion detection is performed.

Store mode: «Snapshot» – save photo if software motion detection has occurred;

«Record» – save video if software motion detection has occurred.

Notification – «On» or «Off». Enable or disable sound alarm if software motion detection has occurred.

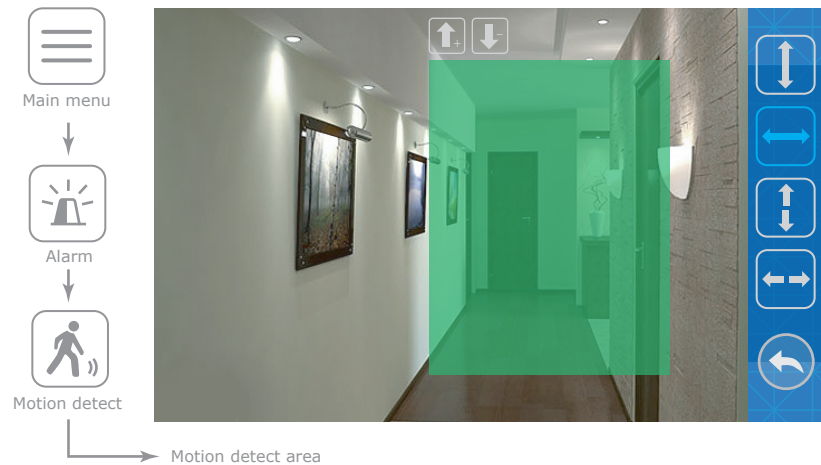
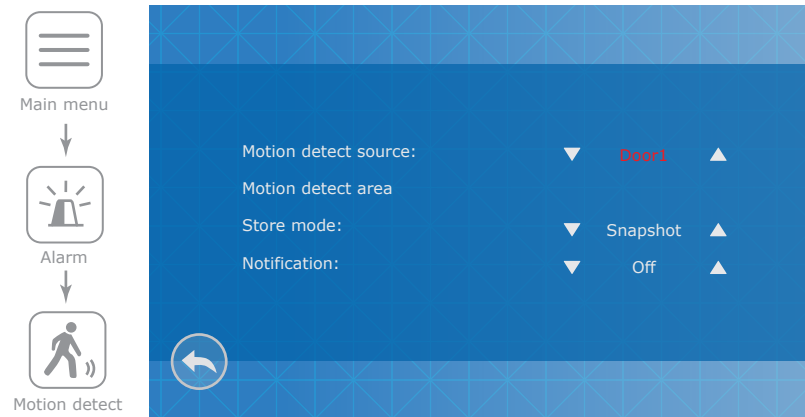

6.6 Display settings

Press «Color» icon in the main menu to enter display settings.

Following parameters are available in the «Color» menu:

Door1 – image settings for the first door panel.

Door2 – image settings for the second door panel.

CAM1 – image settings for the first CCTV camera.

CAM2 – image settings for the second CCTV camera.

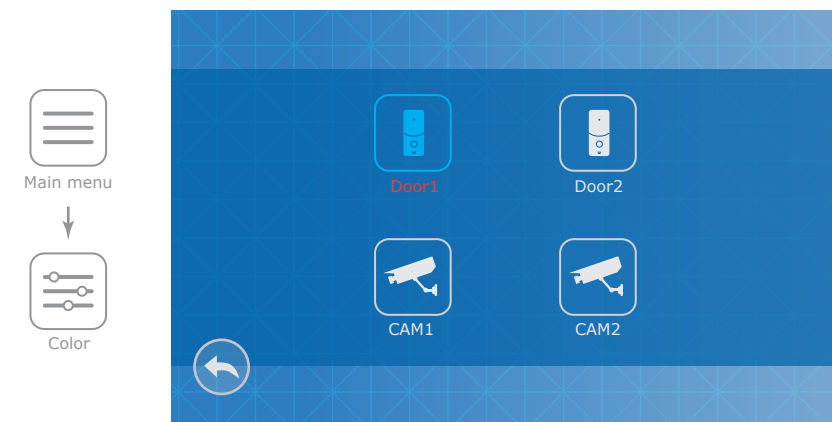

Every video source has its own image settings:

Brightness – parameter range from 0 to 50, 25 used by default.

Contrast – parameter range from 0 to 50, 25 used by default.

Color – parameter range from 0 to 50, 25 used by default.

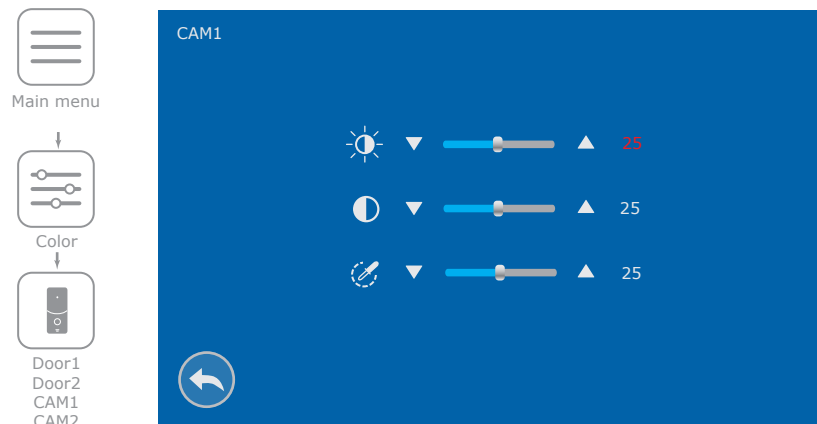

6.7 Snapshots and records playback

Press «Files» icon in the main menu to enter snapshots and records playback.

Following parameters are available in the «Files» menu:

Record files – records playback.

Snapshot files – snapshot files playback

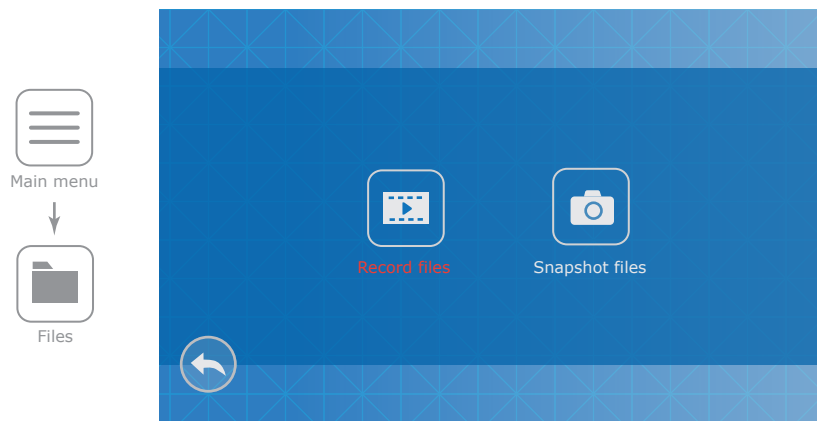

Select «Record files» or «Snapshot files» icon, then press file name to start playing.

While playing press  button to go back to the files list.

If you want to delete the file press and hold the finger for two seconds on selected file name. File context menu will appear on the screen. Select one of three options:

Play – current file playing;



Delete current file – current file deleting;

Delete all files – all files deleting

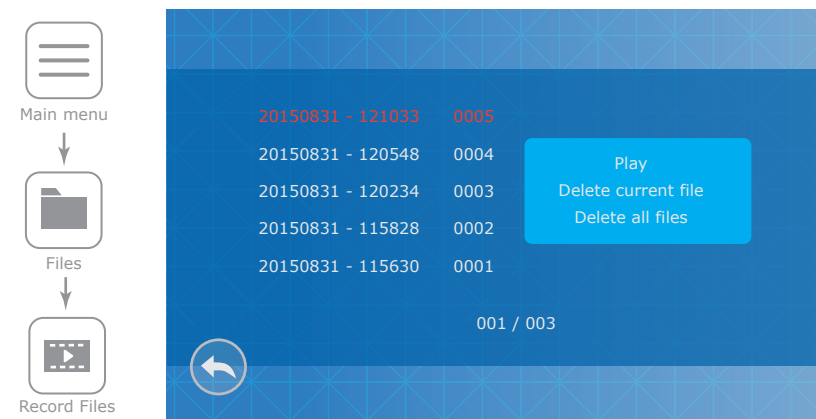
or press  button to close context menu.



7. Manual and automatic recording

User can take snapshots or record video during monitoring door panel or CCTV camera. Press  icon on the screen to take snapshot or press  icon on the screen to start video recording. Press the same button second time to stop video recording.

Depending on the «Record mode» setting (page 17) monitor will be automatically taking snapshots or recording video while incoming call from the door panel.

Note:

Video can be recorded only if microSD card installed into monitor slot. If microSD is absent then monitor can only record snapshots using internal memory, no matter what «Record mode» has been set.

100 snapshots can be stored in the internal memory. If the quantity exceeds 100 snapshots then older snapshots will be replaced by new one.

8. External sensors motion detection recording

Camera 1 and Camera 2 has motion detection function by external motion sensor. When external sensor connects or disconnects its contacts (depending on «CAM1 sensor type» or «CAM2 sensor type» setting in «Alarm» → «CAM alarm» menu, page 17-18), recording starts on the door monitor. Video recording time is 10 seconds. Press  button to stop recording manually.

Use any external sensors that has normally opened «NO» or normally closed «NC» contacts. When the sensor is activated it connects (NO case) or disconnects (NC case) contacts which activates recording on the door monitor.

External motion sensor connection.

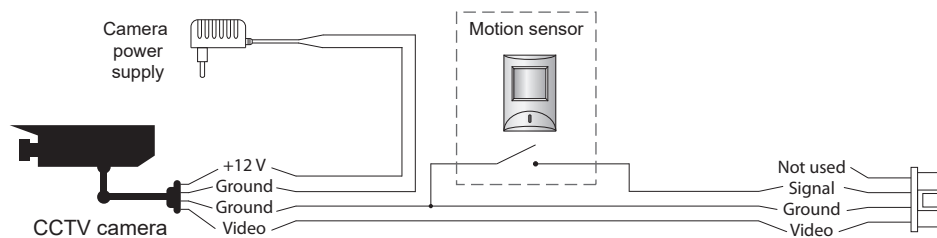

9. Limited warranty

Manufacturer guarantees product normal functioning during the warranty period if the user keeps all safety instructions described in that manual.

Warranty period is 12 months from the moment of the product purchasing (warranty period could be extended up to 24 months or more, depending on the local regulations).

Warranty period allows user to make guarantee repair in cases when normal functioning of the product was violated by the fault of manufacturer and the user haven't offend transporting, installation and working conditions.

This limited warranty does not cover any damage to the product that results from improper installation, accident, abuse, misuse, natural disaster, insufficient or excessive electrical supply, abnormal mechanical or environmental conditions, or any unauthorized disassembly, repair or modification.

Warranty void in such cases:

- the product was damaged by the fault of the customer;
- the product wasn't properly installed according recommendations from the manual;
- the sticker on the backside of the product was broken;
- the product was not used for its intended function.

This limited warranty covers only repair, replacement, refund or credit for defective products, as provided above. Manufacturer is not liable for, and does not cover under warranty, any damages or losses of any kind whatsoever resulting from loss of, damage to, or corruption of, content or data or any costs associated with determining the source of system problems or removing, servicing or installing products. This warranty excludes third party software, connected equipment or stored data. Manufacturer is therefore not liable for any losses or damage attributable to third party software, connected equipment or stored data.

In the event a product has been discontinued, manufacturer shall either repair the product, offer to replace it with a comparable product or provide a refund at the lesser of the purchase price or the product's current value.

Repaired or replacement products will continue to be covered by this limited warranty for the remainder of the original warranty term.